

AUTOMATIC LATHE

star

# SR-10J type C

CNC SWISS TYPE AUTOMATIC LATHE



User-oriented and state-of-the-art machine for small parts makes its debut from Star.

□ TOOL POST

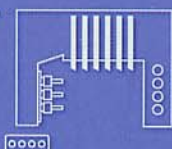

□ WORK SIZE (MAX.)



□ CONTROL SYSTEM



CNC SWISS TYPE AUTOMATIC LATHE

# SR-10J type C

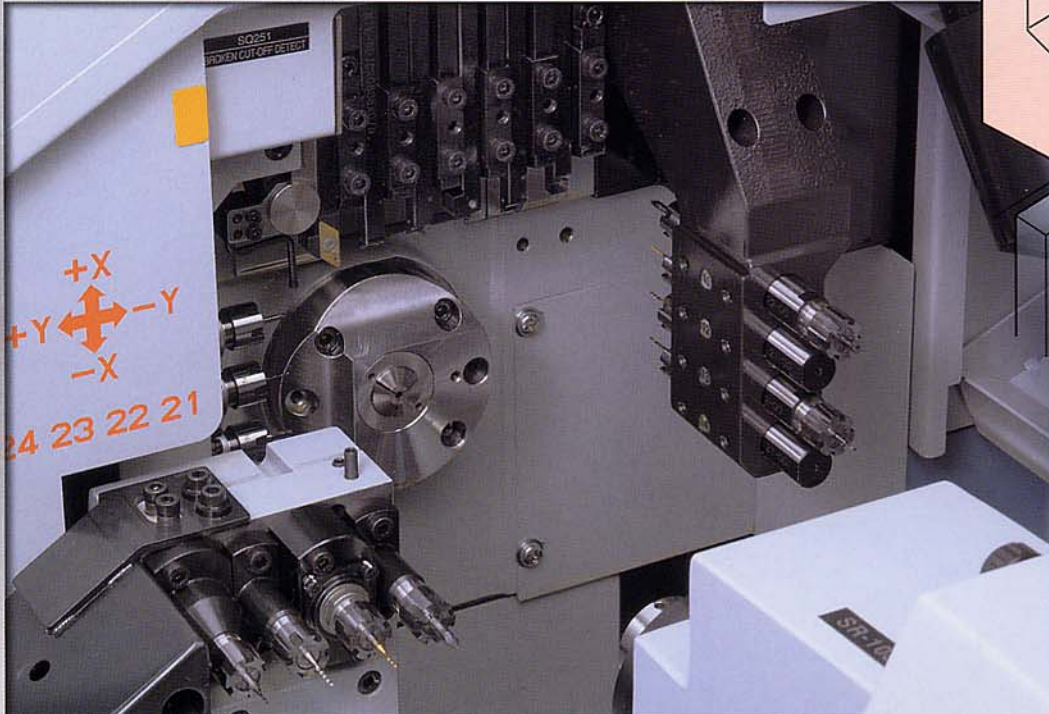
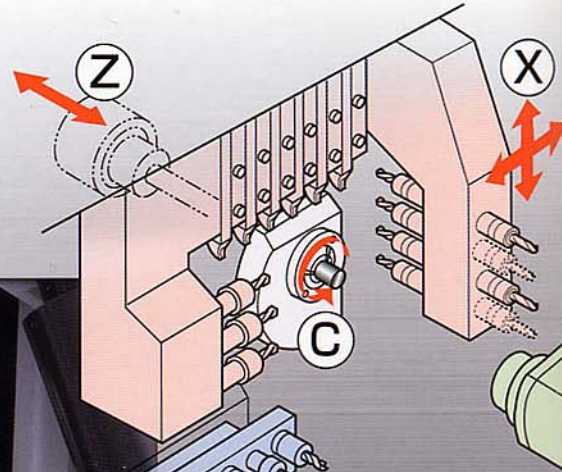

## **SR-10J, a 10mm $\phi$ class machine to satisfy "low cost," "space-saving" and "high productivity" performance**

*A low-cost and space-saving machine possessing C-axis control and multifunction capabilities achieving high levels of productivity*

### FEATURE of SR-10J CNC SWISS TYPE AUTOMATIC LATHE

#### **High cost performance**

- The ultimate low cost machine achieving dynamic design and manufacture.

#### **Space-saving**

- A depth of 775mm. The floor area is 30% less than the area required for SB-16. The productivity per unit area can be increased owing to the footprint size.

#### **Reducing machining time and idle times**

- Reduced idle time by using a layout where the tool post traveling distance is shorter than a normal, incorporating an approaching function and a high-speed feed.
- Overlap machining is available for the front and back sides by using a back-working unit.

#### **Satisfactory secondary machining**

- The main spindle equipped with the C-axis control.
- The power-driven tool unit for cross working operation attached to the gang tool post.
- The slotting to the rear end is available with a back-working unit.

#### **High accuracy**

- Adopting a synchronous control of the Z/ZB axes and a phase synchronous control of the main-/sub-spindle.
- Tool cutting position close to the guide bush enhances accuracy for small parts machining.

#### **Harmony within the environment**

- Hydraulic units eliminated, reducing oil waste and electric power consumption.

VARIATION : 01

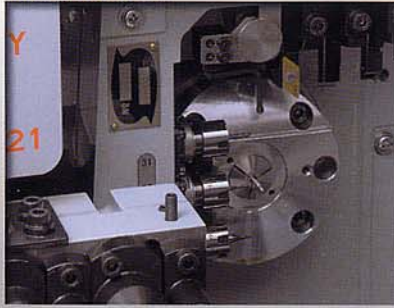

Cross milling

Y

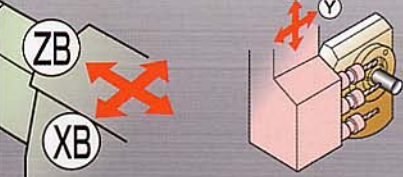

VARIATION : 02

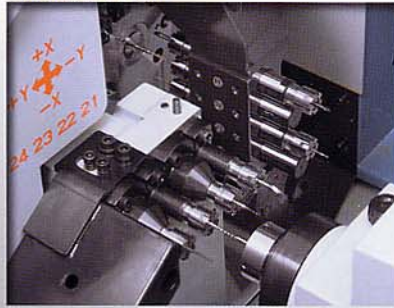

Main/sub spindle rigid tapping

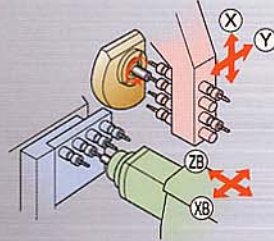

VARIATION : 03

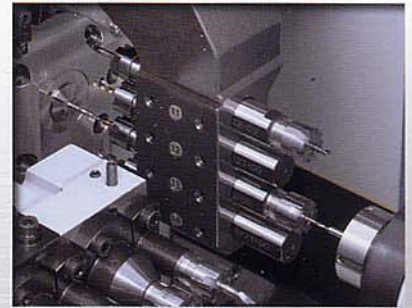

Main/sub spindle simultaneous drilling

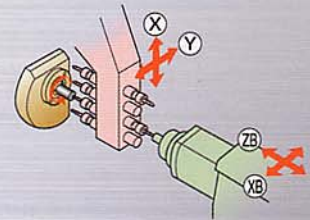

VARIATION : 04

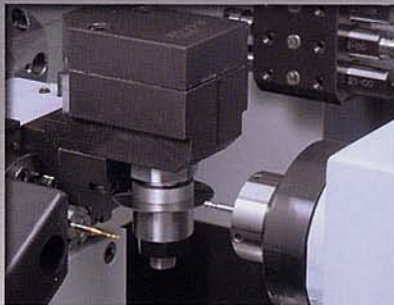

Back Slotting

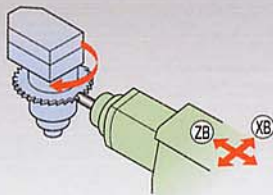

VARIATION : 05

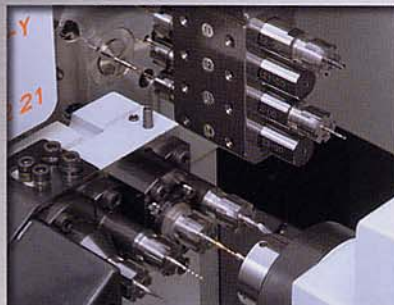

Back off-center drilling

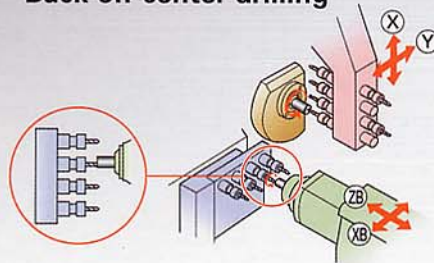

**A Variety of back machining with power-driven tools (optional)**

Mounting a drive unit for power-driven tools on the back 4-spindle unit enables such machining as off-center drilling, off-center tapping, milling and rigid tapping.

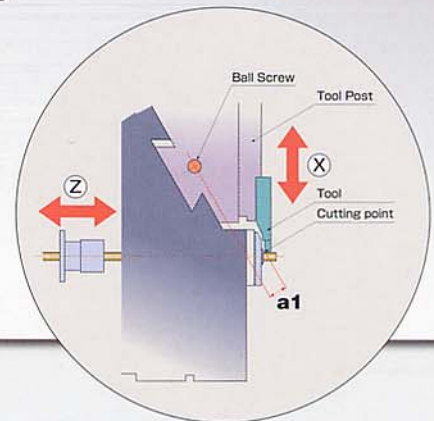

**HIGH PRECISION**

**DESIGN**

**Star original rigid "slanted dovetail slideway structure" for improved dimensional accuracy and tool life.**

The Y-axis slideway of the tool post incorporates a slanted dovetail structure. Because of this, the X- and Y-axis slideways can be arranged in a radial pattern close to the cutting point, increasing machine rigidity. In addition, a straight line, passing through the ball screw center, in parallel with the Y-axis slideway and the cutting point are close to each other (a1), reducing the moment load caused by cutting resistance and improving rigidity.

This enhanced rigidity leads to dynamic stability during cutting, improves dimensional accuracy during long continuous operation, and contributes to the productivity increases.

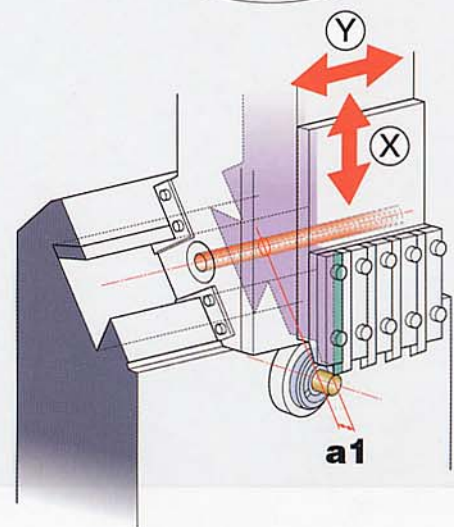

## Standard Machine Specifications

OP : Option

Item	Specifications
Max. machining diameter	φ 10mm (25/64in)
Max. headstock stroke	Stationary GB 135mm (5-5/16in) Revolving GB 105mm (4-9/64in)
Tool	6 tools (□8mm)
4-Spindle sleeve holder	Number of tools
	Front 4 tools
	Rear 4 tools
Max. drilling capacity	φ6mm (15/64in)
	Max. tapping capacity
Power driven att.	Number of tools
	Max. drilling capacity
	Max. tapping capacity
Main spindle min. indexing degree	C-axis control
Main spindle speed	Max.15,000min <sup>-1</sup>
Main spindle motor	2.2kw(continuous)/3.7kw(15min.)
Rapid feed rate	35m/min(X, Y, Z, XB, ZB)
Power-driven att. spindle speed	Max. 10,000min <sup>-1</sup>
Power-driven att. drive motor	0.5kw
Coolant tank capacity	85 ℓ
Dimensions (W×D×H)	1,865×775×1,695mm
Center height	1,050mm
Weight	1,400kg
Power consumption	3.5KVA

## Standard Accessories and Functions

- |   |                                |
|---|--------------------------------|
| 1. Pneumatic unit                         | 8. Short circuit breaker       |
| 2. Coolant level detector (lower limit)   | 9. Backworking Attachment      |
| 3. 4-Spindle sleeve holder                | 10. Sub spindle air purge unit |
| 4. 3-Spindle cross drilling unit          | 11. Parts ejection detector    |
| 5. Automatic centralized lubrication unit | 12. Sub spindle air blow unit  |
| 6. Door interlock unit                    | 13. Work light                 |
| 7. Broken cut-off tool detector           | 14. Tool kit (1 Set)           |

## Optional Accessories and Functions

- |                                  |  |
|----------------------------------|--|
| 1. Transformer                   | 10. 4-Spindle unit for back working (For stationary tools at back)               |
| 2. Main spindle inner tube 6mm   | 11. Drive unit for the power-driven tool Type B (For power-driven tools at back) |
| 3. Rotary guide bush drive unit  | 12. Parts separator unit A   |
| 4. Rotary magic guide bush unit  | 13. Main spindle clamp unit  |
| 5. Air purge unit                | 14. Sub spindle clamp unit   |
| 6. Coolant flow detector         | 15. Transformer CE marking specifications  |
| 7. Automatic barfeeder interface |  |
| 8. Water removal unit            |  |
| 9. Tool for maintenance          |  |

## Backworking Attachment Specifications

OP : Option

Item	Specifications
Max. chucking diameter	φ 10mm (25/64in)
Max. length for front ejection	70mm (2-3/4in)
Max. parts projection length	20mm (25/32in)
Back 4-Spindle unit	Number of tools
	4 tools : OP
	Max. drilling capacity
	Max. tapping capacity
Stationary tool	φ 4mm (5/32in)
	M3×P0.5
Power driven tool	φ 4mm (5/32in)
	M3×P0.5
Sub spindle min. indexing angle	15° : OP
Sub spindle speed	Max. 10,000min <sup>-1</sup>
Sub spindle motor	0.55kw(continuous)/1.1kw(15min.)

Note)  
The above machining capacities apply to SUS303 material.  
The machining capacities may differ from listed values depending on the machining conditions, such as the material to be machined or the tools to be used.

## External Dimensions and Floor Space

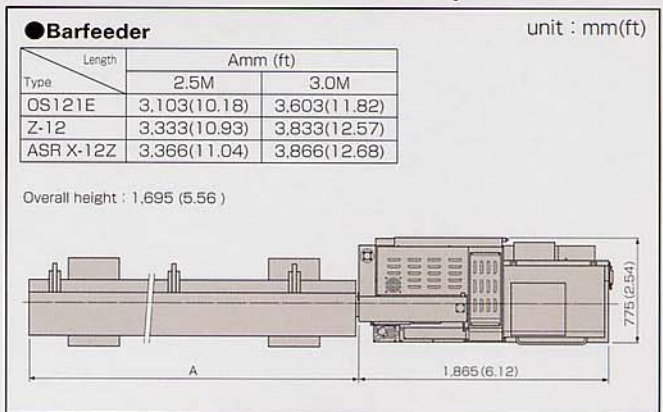

※Design features, specifications and technical execution are subject to change without prior notice.

※This product is an export control item subject to the foreign exchange and foreign trade laws. Thus, before exporting this product, or taking it overseas, contact your STAR MICRONICS dealer.

# STAR MICRONICS CO., LTD.

## Machine Tools Division

1500-34 Kitanoya, Misawa, Kikugawa, Shizuoka, 439-0023 Japan

America, Europe Sales TEL.+81-537-36-5594 FAX.+81-537-36-5607

Asia Sales TEL.+81-537-36-5574 FAX.+81-537-36-5607

### Star CNC Machine Tool Corporation

123 Powerhouse Road, Roslyn Heights, NY 11577, U.S.A.  
TEL.+1-516-484-0500 FAX.+1-516-484-5820

### Star Micronics GB Limited

Chapel Street, Melbourne, Derbyshire DE74 8JF, U.K.  
TEL.+44-1332-86-44-55 FAX.+44-1332-86-40-05

### Star Micronics GmbH

Untere Reute 44, D-75305 Neuenbürg, Germany  
TEL.+49-7082-79200 FAX.+49-7082-792020

### Star Micronics AG

Lauetstrasse 3, CH-8112 Otelfingen, Switzerland  
TEL.+41-43-411-60-60 FAX.+41-43-411-60-66

### Star Machine Tool France SAS

55 Avenue du Mont Blanc, F-74950 Scionzier, France  
TEL.+33-450-96-05-97 FAX.+33-450-96-91-54

### Shanghai Xingang Machinery Co., Ltd.

229 Fute Road(N) Waigaoqiao F. T. Z. Shanghai 200131, P.R.China  
TEL.+86-21-5868-2100 FAX.+86-21-5868-2101

### Star Micronics (Thailand) Co., Ltd.

49/30 M-4 Soi Kingkaew 30, Kingkaew RD., Rachathewa A. Bangplee, Samutprakarn 10540, Thailand  
TEL.+66(0)2-750-4083 FAX.+66(0)2-750-4085

